

SINGLE HORIZONTAL CONTACTS 12-28 AWG

201-01-150

1. SPECIFICATION DISTRIBUTION

No restrictions for issue

2. SCOPE

This specification contains the application notes for the horizontal 9296 poke home SMT mount contacts. Wire inserted horizontally, parallel to the PCB surface.

3. RELATED DOCUMENTS

70-9296-001-XXX-006S – Sales Drawing, horizontal

201-01-142 – Product Specification – horizontal contacts.

Note: The colours used in this specification are for clarity only.

4. 9296 HORIZONTAL MOUNT CONTACTS 2mm, 3mm and 4mm

70-9296-001-004-006 4mm contacts to accommodate 12AWG to 20AWG wires with a maximum insulation diameter of 3.4mm.

70-9296-001-003-006 3mm contacts to accommodate 18AWG to 26AWG wires with a maximum insulation diameter of 2.5mm.

70-9296-001-002-006 2mm contacts to accommodate 22AWG to 28AWG wires with a maximum insulation diameter of 1.50mm (see section xx).

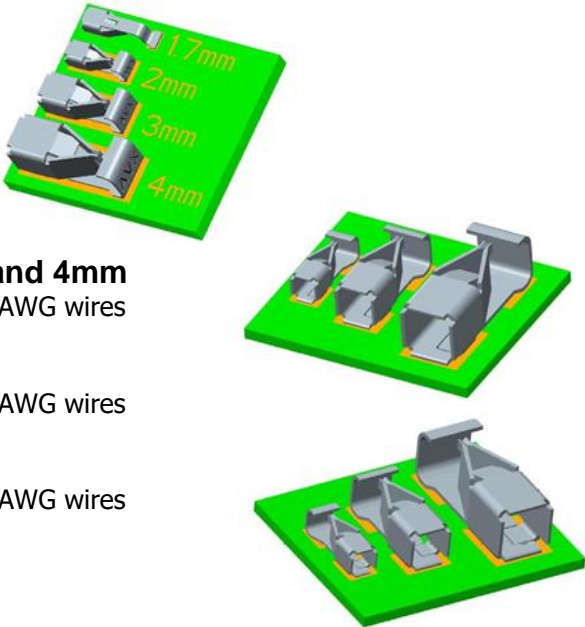

4.1. UL REQUIREMENTS FOR PAD SPACING

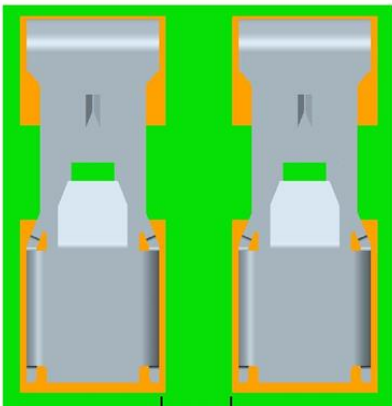

For UL applications
3.2mm minimum

UL approval based on 3.2mm gap between pads.

Minimum contact centre spacing 1.7mm contacts 5.0mm. Minimum contact centre spacing 2mm contacts 5.4mm. Minimum contact centre spacing 3mm contacts 6.6mm. Minimum contact centre spacing 4mm contacts 7.6mm.

For non UL applications the gap may be reduced at the customers discretion depending on the voltage applied.

4.2. SUITABLE WIRES

4mm contact all solid (single conductor) wires from 20AWG to 12AWG with max insulation of 3.4mm.
 3mm contact all solid (single conductor) wires from 26AWG to 18AWG with max insulation of 2.5mm.
 2mm contact all solid (single conductor) wires from 11AWG to 30AWG with max insulation of 1.5mm (ref xxx).

Stranded wires work best with a smaller number of strands (larger strand diameter). We recommend that ALL stranded wires after stripping are bunched and twisted to achieve better retention forces within the contact.

Stranded wires with a larger number of strands (thinner strands) can be used but it is important that all the strands are tightly twisted to gain maximum strength. It is possible to tin the ends but the conductor diameter must not exceed 2.1mm for the 4mm contact, 1.1mm for the 3mm contact and 0.65mm for the 2mm contact.

All wire types can be used in both plated and un-plated condition.

5. 9296 WIRE TERMINATION PROCEDURE (HORIZONTAL)

5.1. WIRE STRIPPING

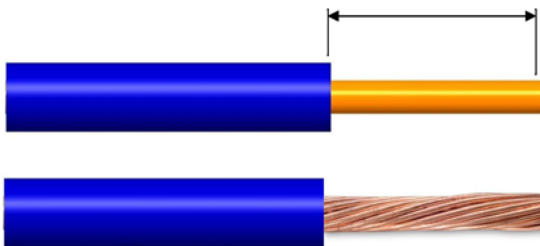

Insulation Strip Length

Stranded wire should be tightly bunched and twisted before insertion.

70-9296-001-002-006 2mm contact.

Wire insulation strip length for 28/26/24/22AWG wires is recommended to be 3mm to 4mm (section 5.3).

70-9296-001-003-006 3mm contact.

Wire insulation strip length for 26/24/22/20/18AWG wires is recommended to be 4mm to 5mm.

70-9296-001-004-006 4mm contact

Wire insulation strip length for 20/18/16AWG wires is recommended to be 5mm to 6mm.

Wire insulation strip length for 14/12AWG wires is recommended to be 6mm to 7mm.

5.2. WIRE INSERTION

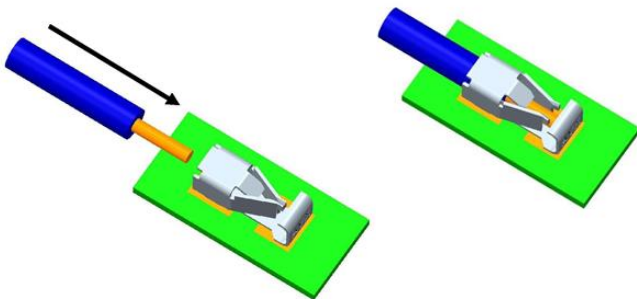

Wires are inserted through the front aperture of the contact. They should be pushed beyond the grips up to the stop face.

For smaller wires especially 26AWG and 28AWG stranded wire it may be necessary to use the tool to open the contact slightly when wires are inserted.

NOTE when inserting wires, it is expected that the side walls of the contact deflect outwards, this is normal and a function of the wire being inserted into the contact.

Stop Face

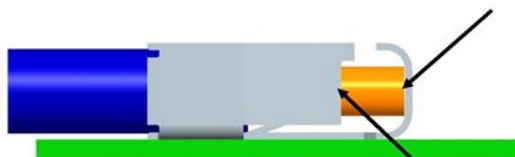

Wire Tine Grips

5.3. OVERSIZE WIRE IN 70-9296-001-002-006

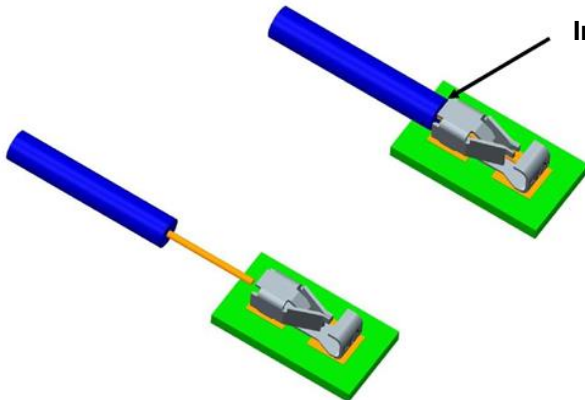

Insulation Outside Contact

For wires with insulation 1.5mm to 2.0mm diameter it is possible to assemble with the insulation not entering the contact. Trim length is increased to 5mm to 6mm

6. MANUAL WIRE REMOVAL

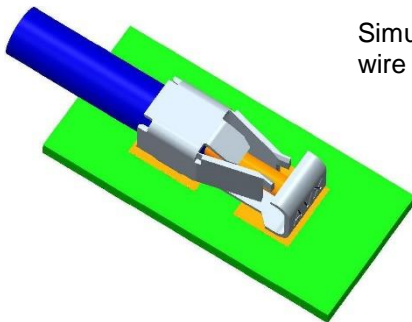

Simultaneously pull and twist wire back and forth, the wire will slowly screw out of the contact.

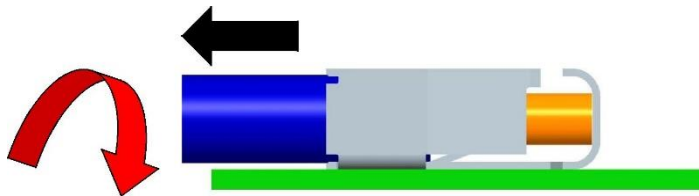

7. 9296 HORIZONTAL MOUNT CONTACTS 1.70mm

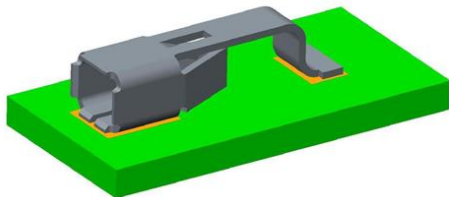

70-9296-001-017-006 1.7mm contacts to accommodate 22AWG to 26AWG wires with a maximum insulation diameter of 1.30mm (see notes in 9.1 and 9.2).

7.1. SUITABLE WIRES

1.7mm contact all solid (single conductor) wires from 22AWG to 26AWG with a maximum insulation diameter of 1.3mm. Wires with an insulation greater than 1.3mm diameter can be accommodated with a modified assembly procedure, refer to section 12.1 and 12.2.

Stranded wires work best with a smaller number of strands (larger strand diameter). We recommend that ALL stranded wires after stripping are bunched and twisted to achieve better retention forces within the contact.

Stranded wires with a larger number of strands (thinner strands) can be used but it is important that all the strands are tightly twisted to gain maximum strength. It is possible to tin the ends but the conductor diameter must not exceed 0.82mm diameter.

All wire types can be used in both plated and un-plated condition.

8. 9296 WIRE TERMINATION PROCEDURE (HORIZONTAL)

8.1. WIRE STRIPPING

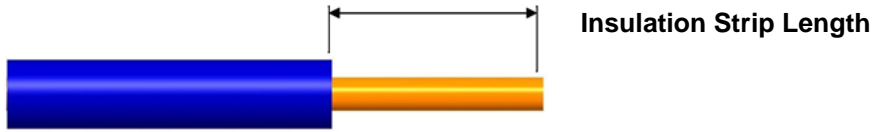

70-9296-001-017-006 1.7mm contact

Wire insulation diameter 1.3mm or less strip length wires is recommended to be 3.5mm to 4.5mm.

Wire insulation diameter 1.3mm to 1.7mm strip length wires is recommended to be 5.5mm to 6.5mm.

8.2. WIRE INSERTION

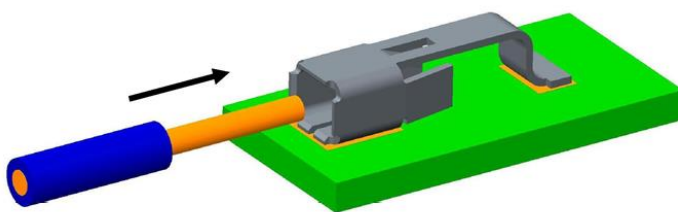

Wire should be inserted from direction shown.
Wire must be straight when inserted.

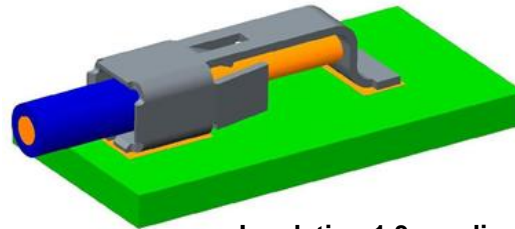

Insulation 1.3mm diameter or smaller

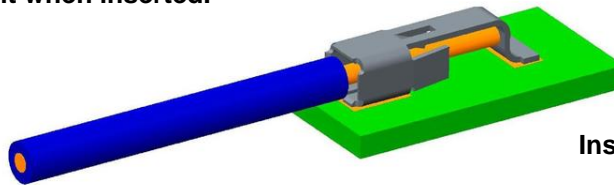

Insulation greater than 1.3mm diameter

9. EXTRACTION PROCESS

9.1. MANUAL WIRE REMOVAL

Simultaneously pull and twist wire back and forth, the wire will slowly screw out of the contact.

