



TANTALUM CAPACITORS TECHNOLOGY FOR EXTENDED OPERATING TEMPERATURE RANGE

T.Zedníček, Z.Sita, S.Pala

AVX Czech Republic s.r.o., Dvorakova 328, 563 01 Lanskrout, Czech Republic
Phone: +420 465 358 126 Fax: +420 465 358 128

A B S T R A C T

New materials, capable to operate at higher temperatures, new techniques of their processing and new procedures for increasing the stability have been implemented to AVX THJ series to extend the continuous operating temperature up to 175°C while maintaining twice better reliability specification compare to the standard range of tantalum capacitors.

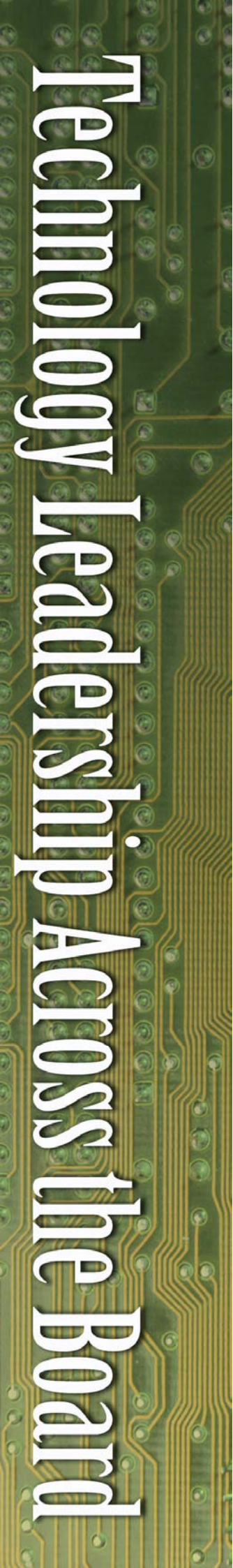

ABSTRACT

Tantalum technology is currently capable to meet specifications of automotive industry for high temperature capacitors up to 175°C while respecting the requirements for high reliability. Demand for even higher operating temperature has been seen recently for new applications.

New materials, capable to survive storage at higher temperatures, new techniques of their processing and new procedures for increasing the stability had to be developed for the new AVX THJ series of automotive tantalum capacitors to improve working temperature of capacitors while maintaining high reliability.

Newly developed tantalum technologies enable continuous operation at temperature up to 175°C. The climatic category is -55/175/56 with a basic series reliability of 0.5%/1000 hours, and the technology is ready for leadfree high peak temperature mounting and hybrid assembly types.

The paper describes results of further development on high temperature tantalum capacitors as a continuous effort [3].

INTRODUCTION

Automotive electronics is a fast and continuously growing area of the automotive industry. Electronics replaces mechanical or human controls and add additional sophisticated features that make cars safer and more reliable than ever before. The trend makes towards increasing number of electronic components per car. Electronics of basic car models represents approximately 15% of their total cost, while in luxury cars it has already exceeded 40% with continuous increase of these percentages.

Automotive electronics appears in wide range of applications, from cabin entertainment, through airbags and ABS to applications directly on engine. Each of them has different requirements by their location within the vehicle. It creates various demands on operating temperature, process voltage and reliability.

Maximum operating temperature for cabin applications is <85°C, whereas for engine compartment it is < 175°C, but the trend is, that temperature of engine applications increases due to continuing integration of on-engine applications.

The current power output demand for all the automotive electronics on board exceeds the capability of conventional 14V battery and a 42V power system is under investigation now in order to meet demand from the high power consuming applications on engine.

Reliability is a driving force of the automotive industry and it is one of the most important parameters that have to be taken in account for high temperature ranged capacitors in addition. Better performance of parts at higher operating temperatures must be supported by improvement of reliability.

NEW DEMANDS OF AUTOMOTIVE INDUSTRY ON TANTALUM CAPACITORS

Operating temperature

Standard tantalum capacitors technologies offer the temperature range from -55°C to +125°C which limits their usage only to cabin entertainment and other lower temperature applications. Some producers put on the market automotive families, which expand the possible usage of tantalum capacitors to engine compartment systems with requirements for continuous operating temperature up to 150°C [3].

The automotive industry requires development of 175°C operating temperature capable components with further extension up to 200°C in few years time – see Fig.1.

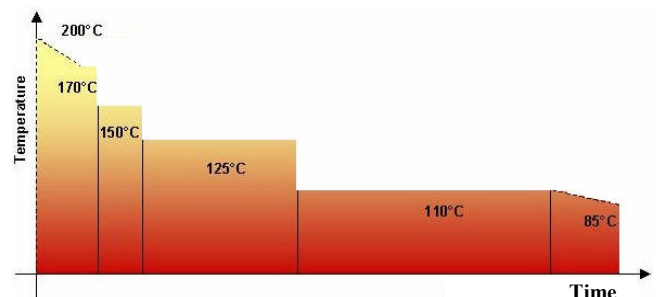

Fig.1. Trend in time at temperature profile of tantalum capacitors

New research has been focused on increasing the operating temperature for limited time to higher values up to 175°C. The stability against thermal shocks -55/+175°C and the long-term stability at 175°C were measured to prove the capability of the new designs.

The development was focused not only at 175°C, but it was made in consideration of possibility to use higher temperatures up to 200°C or more.

Voltage rating

The standard tantalum technology voltage range is maximum fifty volts and temperatures from -55°C up to 125°C. Higher temperature tantalum capacitors for 175°C operation, are rated to thirty-five volts in wide range and to fifty volts in limited codes.

Extension of the rated voltage up to 60V is a challenge, not achieved yet by the current technology. A series combination of two 35V capacitors can be used in the interim to meet the higher voltage requirements [2].

Both 14V, and 42V battery supplies consist of step down DC/DC converters to 8V, 5V or even lower voltages. The lower voltage makes the range of capacitors used for automotive electronics even wider.

Reliability

There are high lifetime requirements of the automotive industry in addition to the high temperature features. That is why tantalum capacitors, which are capable to survive high temperatures such as 175°C, should meet at least twice better reliability (0.5%/1000 hours), than standard tantalum technology (1%/1000 hours).

MATERIAL DEVELOPMENT

Higher operating temperature poses the claim on temperature stability of all materials used for production of the capacitors from chemical and from mechanical point of view. Materials have to be designed to survive both high temperature stresses and storage.

Maximum operating temperature of materials was studied to prove long term stability of materials at elevated temperatures using the laboratory testing methods. The stability was then confirmed by testing the electrical and mechanical performance of finished capacitors. Fig.1 shows an example of TGA stability test of silver material being used in construction of capacitor, which proves its stability up to 250°C.

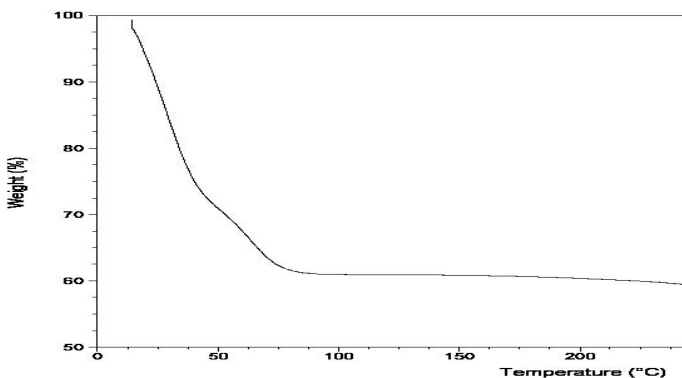

Fig.1. TGA of silver material

Extension of application temperature to 175°C required that special attention was paid mainly to three groups of materials – tantalum anode, encapsulant and terminations. Other materials as carbon, silvers, however, could not be omitted, too.

Tantalum anode

Reliability testing proved, that tantalum capacitors with MnO₂ counter electrode are capable of the storage at higher temperatures provided specific rules are abided. Similar rules as for development the 150°C capacitor were taken [3], supported by four years experience and massive reliability data from production. It allowed to specify materials, designs and procedures with long known reliability history, which resulted in highly reliable capacitors even after storage or cycling at 175°C.

Tantalum powder type is crucial for creating a robust anode. Powders from various producers differ marginally by its granulometry, porosity or purity, which in final stage influences the reliability of capacitors. Proper choice of powder type guaranteed the level of stability required by automotive industry even at 175°C.

Forming of homogenous dielectrics with maximum safety ratio, together with robust anode wall structure gave the tantalum anode, which was able to absorb thermomechanical stresses and to survive adverse environmental conditions as high temperature or humidity.

Tantalum capacitors are 100% screened during the production at accelerated conditions to eliminate potential failures. The capacitors are being overstressed by combinations of high voltage and temperature, cyclic thermal shocks or current surges. Robust anode design allowed modifying the screening operations towards temperatures as high as 175°C. All capacitors see the high temperature already at accelerated tests during its production, which guarantees the reliability at end users.

To ensure high surge current resistance, a sophisticated dynamic multiple surge test with extremely low serial resistance (see Fig.3) was used to model the worst possible surge conditions at customers and to sort out the weaker parts which may potentially fail at customer. All capacitors are 100% screened by this surge and potential failures are automatically removed.

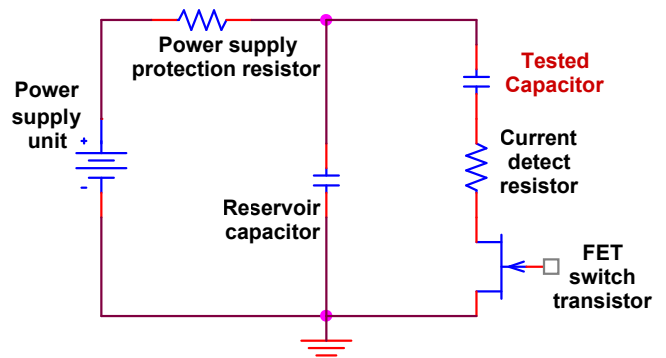

Fig.2.. Circuit of surge testing with dynamic monitoring éf features

Encapsulation

Encapsulation material shall be designed to reduce stresses coming from thermal shocks, to survive high temperature and to create effective barrier to humidity penetration.

The resistance against thermal shocks can be reduced by low thermal expansion and high glass transition temperature of the moulding compound.

High strength at high temperature and good adhesion to leadframe reduces the chances of cracking the encapsulant and opening the gate for humidity penetration. The IPC level 2 is a minimum required level of cracking resistance, and a material which meets the IPC level 1 to improve the humidity stability is in development. Low water absorption of encapsulant can further improve the humidity resistance.

Leadfree technology starts to be widely used in automotive industry. The leadfree technology requirement contains the compatibility of product with leadfree reflow with peak temperature up to 260°C, and the compatibility with environmental standards which ban using Sb/Br compound as fire retardants. The encapsulant was designed meet both specifications.

The encapsulant should show stable colour with marking, legible after storage at 175°C. Fig.3 and 4 compare the legibility after ageing of old and new moulding compound.

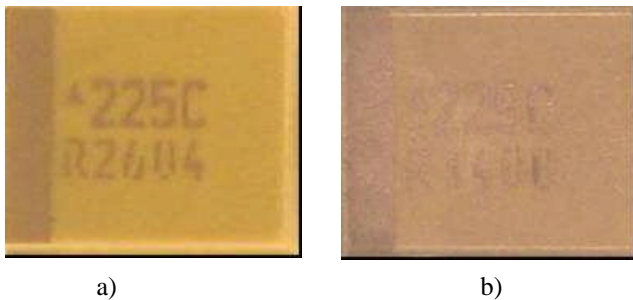

Fig. 3. Standard moulding compound a) pre-thermal exposure and b) post 2000 hrs at 125°C

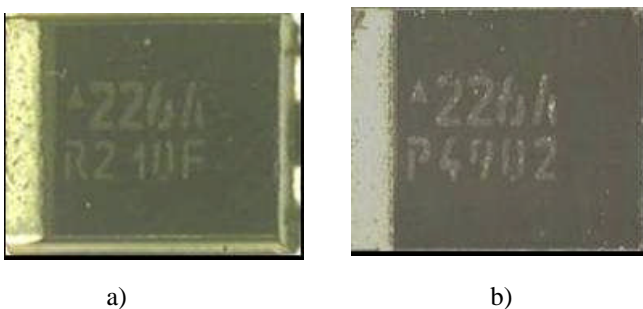

Fig. 4. New moulding compound a) pre-thermal exposure and b) post 2000 hrs at 150°C and 50 hrs at 175°C

Terminations

The termination plating has to meet high temperature storage and environmental requirements. The plated leads mounted by leadfree profile to PCB must have excellent shear force after exposure to 175°C. Three types of plating styles are considered:

a) Gold plating

Recommended especially for hybrid circuit applications as a environmentally friendly high reliable and temperature stable plating

b) Leadfree compatible plating

With the upcoming lead free environmental requirements, the 100% tin finish is available. The pure tin plating gives low cost solution with equal solderability to conventional SnPb solder, and higher reflow temperature robustness up to 260°C to fulfil lead free soldering specification.

c) Standard Sn/Pb plating

An effective barrier system enables the use of standard Sn/Pb plating.

RESULTS AND RELIABILITY VERIFICATION

Testing route

The full set of reliability tests according to CECC 30 800/ IEC-QC300 800/ AEC-Q200 specifications were modified to cover the climatic category 55/150/56. All necessary testing limits and temperatures were consequently extended to 175°C – see Tab.1.

Extended IEC-OC 300 800 tests

- Life 175°C/0,5Ur/2000hrs
- Rapid change of temperature -55°C/175°C/30min, 100 cycles
- Temperature characteristic – (20/-55/85/125/175/20)°C
- Surge 150°C/0,66Ur/1000x surge/Ry=33ohm
- Climatic sequence-dry heat 175°C
 - damp heat cycle, 1 cycle
 - cold -55°C
 - damp heat cycle remaining

Table. 1. Extended IEC-QC 300 800 tests

Capacitors, made by high temperature, high reliability technology was subjected to environmental testing matrix according to extended IEC-QC 300 800 standard.

In addition, combinations of the above mentioned tests were used to get as more information as possible about the stability and reliability of parts.

Results of Combined Tests

Test A: Load temperature, storage, cycling and load humidity

The test A was designed to combine long term storage at 150°C with 0.5 rated voltage load, followed by 175°C 0.5 rated voltage, high temperature cycling and long term storage in high humidity conditions. Seven production lots from capacitors dedicated for 175°C operation were tested. High voltage codes and case sizes A,B and D were used for the test, 50 pcs of each lot (see Tab.2).

The results are shown in table 3. All capacitors passed the test without any parametric or catastrophic failure.

Combination A:

- T1 - Electrical duration tests (150°C, 0.5Ur, 2000h)
- T2 - Electrical duration tests (175°C, 0.5Ur, 100h)
- T3 - Temperature cycling (-40/175°C, 1000 cycles)
- T4a - Temperature cycling + humidity & bias (-40/175°C, 100 cycles, 40°C/93%RH, Ur, 500h)
- T4b - Temperature cycling + humidity, no bias (-40/175°C, 100 cycles, 40°C/93%RH, Ur, 500h)

Table 2. Description of test A

Test	Description	Lots tested	Qty Tested	Number Failed
T1	Electrical Duration Test 1	7	350	0
T2	Electrical Duration Test 2	7	350	0
T3	Temperature cycling	7	350	0
T4	Temperature cycling + Humidity, Bias Y/N	7	350	0

Table 3. Stability results of test A

Test B: Gradual temperature cycling

Newly developed capacitors of case sizes A,B,C,D, two production lots of each case, were subjected to multiple temperature cycling at high temperature, first at 150°C, followed by cycling at 175°C temperature (475 cycles@-40°C/150°C and 50 temperature cycles +20/+175°C, 60 min each). The results confirm high stability of electrical parameters after exposition on higher temperature – see Tab.4 and App.1. Again, all capacitors passed the test.

Temperature of cycles	Number of cycles	Tested units	Failures				
			SC	LI	C	DF	ESR
-40°C/150°C	475	927	0	0	0	0	0
20°C/175°C	50	927	0	0	0	0	0

Table 4. Stability results of test B

Verification of specification

Set of test was performed to prove whether the design of capacitors optimised for high temperature storage is robust enough and meets the specification.

Rapid change of temperature -55/175°C

Capacitors from 4 codes A,B,C,D, 2 production lots each, 6000 capacitors in total, were subjected to 100 temperature cycles -55/175°C, each cycle 30 min. Whereas standard capacitors had higher potential for failures during the cycling at 175°C, especially in larger cases, the capacitors designed for 175°C operation showed significantly lower failure level. Both standard series, and new developed capacitors fully meet

CECC 30 800/ IEC-QC300 800 specification requirements, but capacitors designed for 175°C temperature application show 25x better reliability. No catastrophic failures were observed, only capacitors failed only by parametric failure mode.

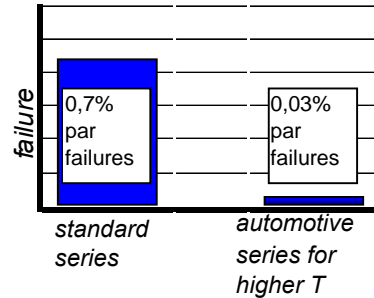

Fig.5. Rapid change of temperature cycles -55/170°C, each cycle 30 min on standard and THJ automotive series

Storage at elevated temperature

The accelerated storage test at 200°C (48h) was carried out on the capacitors of 4 codes A,B,C,D, 2 lots of each, 6000 pcs in total, to guarantee the storage stability at temperature 175°C. No capacitor failed. The example of change the electrical parameters on A1µF35V is shown in App.2.

Category voltage

THJ series capacitors are capable of 175°C temperature with category voltage 0.5Ur (half of the rated voltage). The development continues towards extension of the operating temperature up to 200°C with voltage applied. Fig. 5 shows graphically the dependence of category voltage on operating temperature.

Category Voltage U_c versus Temperature

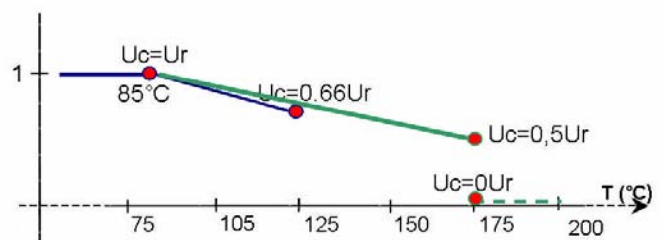

Fig.5. Category voltage vs temperature

- U_c = 0.66U_r at 125°C for standard series
- U_c = 0.5U_r at 175°C for THJ, high temperature
- U_c = 0V (under development THJ 200°C)

CONCLUSION

New designs, processes and material developments have been implemented in order to achieve higher level of tantalum capacitor technology performance available now in AVX THJ series of tantalum capacitors.

Continuous 175°C operation with half of the rated voltage high temperature operation together with twice improved basic reliability specification can be achieved now in order to meet the current demand raised by automotive applications.

The study of materials and processes also shows that even higher specification is obtainable with additional research and technology improvements.

REFERENCES

- [1] Wondrak, W.: „Passive components: Requirements by Automotive Applications“, CARTS '99, New Orleans, USA
- [2] Gill, J.: “Investigation into the effects of connecting tantalum”, AVX Technical publication.
- [3] Zednicek, T. Sita, Z. “New family of Ta capacitors for 150°C operation“ CARTS USA 2000, Proceeding

Appendix A

Test B – A1 μF 35V

Stability of electrical parameters after 475 cycles $40^\circ\text{C}/175^\circ\text{C}$ and 50 temperature cycles $+20/+175^\circ\text{C}$, each 60 min each

- M0 Initial measurement
- M1 Final measurement

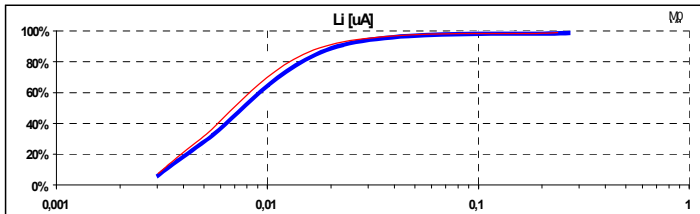

a) DCL

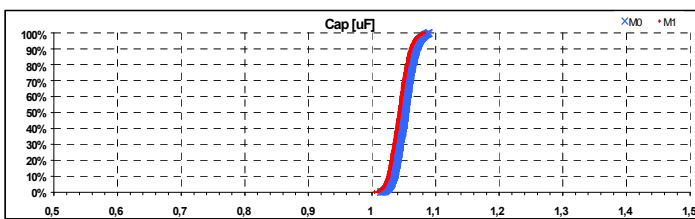

b) Capacitance

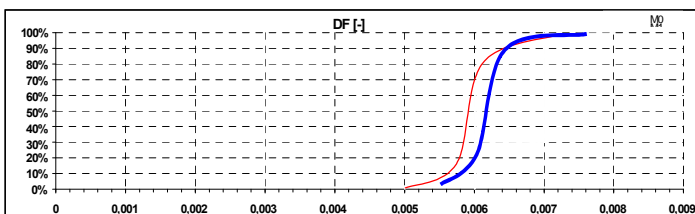

c) Dissipation Factor

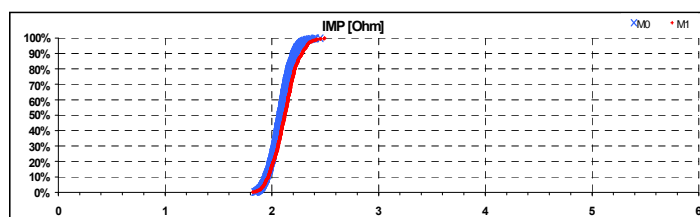

d) Impedance

Appendix B

Storage @ 200°C 48 hrs – A1/35

- M0 Initial measurement
- M1 Final measurement

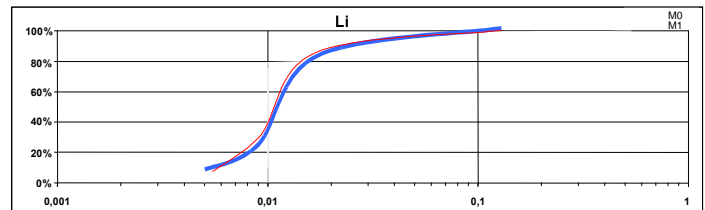

a) DCL

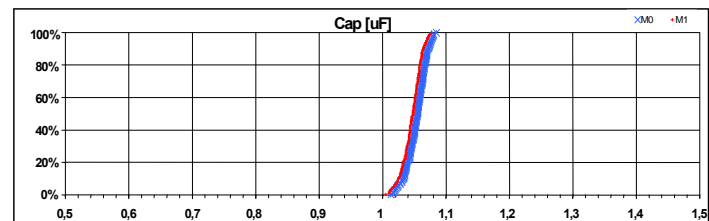

b) Capacitance

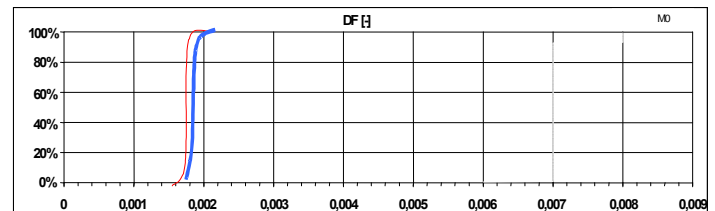

c) Dissipation Factor

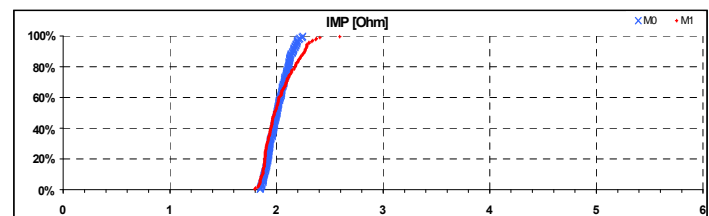

d) Impedance